

ON Semiconductor

Is Now

onsemi™

To learn more about onsemi™, please visit our website at
www.onsemi.com

onsemi and **onsemi** and other names, marks, and brands are registered and/or common law trademarks of Semiconductor Components Industries, LLC dba "**onsemi**" or its affiliates and/or subsidiaries in the United States and/or other countries. **onsemi** owns the rights to a number of patents, trademarks, copyrights, trade secrets, and other intellectual property. A listing of **onsemi** product/patent coverage may be accessed at www.onsemi.com/site/pdf/Patent-Marking.pdf. **onsemi** reserves the right to make changes at any time to any products or information herein, without notice. The information herein is provided "as-is" and **onsemi** makes no warranty, representation or guarantee regarding the accuracy of the information, product features, availability, functionality, or suitability of its products for any particular purpose, nor does **onsemi** assume any liability arising out of the application or use of any product or circuit, and specifically disclaims any and all liability, including without limitation special, consequential or incidental damages. Buyer is responsible for its products and applications using **onsemi** products, including compliance with all laws, regulations and safety requirements or standards, regardless of any support or applications information provided by **onsemi**. "Typical" parameters which may be provided in **onsemi** data sheets and/or specifications can and do vary in different applications and actual performance may vary over time. All operating parameters, including "Typicals" must be validated for each customer application by customer's technical experts. **onsemi** does not convey any license under any of its intellectual property rights nor the rights of others. **onsemi** products are not designed, intended, or authorized for use as a critical component in life support systems or any FDA Class 3 medical devices or medical devices with a same or similar classification in a foreign jurisdiction or any devices intended for implantation in the human body. Should Buyer purchase or use **onsemi** products for any such unintended or unauthorized application, Buyer shall indemnify and hold **onsemi** and its officers, employees, subsidiaries, affiliates, and distributors harmless against all claims, costs, damages, and expenses, and reasonable attorney fees arising out of, directly or indirectly, any claim of personal injury or death associated with such unintended or unauthorized use, even if such claim alleges that **onsemi** was negligent regarding the design or manufacture of the part. **onsemi** is an Equal Opportunity/Affirmative Action Employer. This literature is subject to all applicable copyright laws and is not for resale in any manner. Other names and brands may be claimed as the property of others.



Is Now Part of



ON Semiconductor®

To learn more about ON Semiconductor, please visit our website at www.onsemi.com

Please note: As part of the Fairchild Semiconductor integration, some of the Fairchild orderable part numbers will need to change in order to meet ON Semiconductor's system requirements. Since the ON Semiconductor product management systems do not have the ability to manage part nomenclature that utilizes an underscore (), the underscore () in the Fairchild part numbers will be changed to a dash (-). This document may contain device numbers with an underscore (). Please check the ON Semiconductor website to verify the updated device numbers. The most current and up-to-date ordering information can be found at www.onsemi.com. Please email any questions regarding the system integration to Fairchild_questions@onsemi.com.

ON Semiconductor and the ON Semiconductor logo are trademarks of Semiconductor Components Industries, LLC dba ON Semiconductor or its subsidiaries in the United States and/or other countries. ON Semiconductor owns the rights to a number of patents, trademarks, copyrights, trade secrets, and other intellectual property. A listing of ON Semiconductor's product/patent coverage may be accessed at www.onsemi.com/site/pdf/Patent-Marking.pdf. ON Semiconductor reserves the right to make changes without further notice to any products herein. ON Semiconductor makes no warranty, representation or guarantee regarding the suitability of its products for any particular purpose, nor does ON Semiconductor assume any liability arising out of the application or use of any product or circuit, and specifically disclaims any and all liability, including without limitation special, consequential or incidental damages. Buyer is responsible for its products and applications using ON Semiconductor products, including compliance with all laws, regulations and safety requirements or standards, regardless of any support or applications information provided by ON Semiconductor. "Typical" parameters which may be provided in ON Semiconductor data sheets and/or specifications can and do vary in different applications and actual performance may vary over time. All operating parameters, including "Typicals" must be validated for each customer application by customer's technical experts. ON Semiconductor does not convey any license under its patent rights nor the rights of others. ON Semiconductor products are not designed, intended, or authorized for use as a critical component in life support systems or any FDA Class 3 medical devices or medical devices with a same or similar classification in a foreign jurisdiction or any devices intended for implantation in the human body. Should Buyer purchase or use ON Semiconductor products for any such unintended or unauthorized application, Buyer shall indemnify and hold ON Semiconductor and its officers, employees, subsidiaries, affiliates, and distributors harmless against all claims, costs, damages, and expenses, and reasonable attorney fees arising out of, directly or indirectly, any claim of personal injury or death associated with such unintended or unauthorized use, even if such claim alleges that ON Semiconductor was negligent regarding the design or manufacture of the part. ON Semiconductor is an Equal Opportunity/Affirmative Action Employer. This literature is subject to all applicable copyright laws and is not for resale in any manner.



April 2015

FAN25800 — 500 mA, Low- I_Q , Low-Noise, LDO Regulator

FAN25800 500 mA, Low- I_Q , Low-Noise, LDO Regulator

Features

- V_{IN} : 2.3 V to 5.5 V
- V_{OUT} = 2.7 V, 3.3 V (I_{OUT} Max. = 500 mA)
- V_{OUT} = 2.8 V (I_{OUT} Max. = 250 mA)
- Output Noise Density at 250 mA and 10 kHz = 19 nV/ \sqrt{Hz} (Integrated 8 μ Vrms)
- Low I_Q of 17 μ A in Regulation and Low- I_Q Dropout Mode with Optimized Dropout Transitions
- <70 mV Dropout Voltage at 250 mA Load
- Controlled Soft-Start to Reduce Inrush Current
- Thermal Shutdown Protection (TSD)
- Input Under-Voltage Lockout (UVLO)
- Short-Circuit Protection (SCP)
- Stable with Two 1.5 μ F, 0201 Ceramic Capacitors at V_{OUT}
- 4-Ball WLCSP, 0.65 mm x 0.65 mm, 0.35 mm Pitch, Plated Solder, 330 μ m Maximum Thickness

Description

The FAN25800 is a linear low-dropout regulator with a high PSRR (85 dB at 100 Hz) and low output noise (typically 8 μ V_{RMS} over a 10 Hz to 100 kHz bandwidth). The LDO can provide up to 500 mA of output current.

The enable control pin can be used to shut down the device and disconnect the output load from the input. During shutdown, the supply current drops below 1 μ A.

The FAN25800 is designed to be stable with space-saving ceramic capacitors as small as 0201 case size. The FAN25800 is available in a 4-bump, 0.35 mm pitch, WLCSP package.

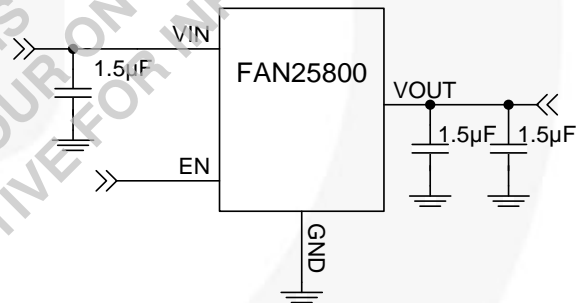

Figure 1. Typical Application

Applications

- WiFi Modules
- PDA Handsets
- Smart Phones, Tablets, Portable Devices

Ordering Information

Part Number ⁽¹⁾	V_{OUT}	I_{OUT_MAX}	Operating Temperature	Package	Packing Method
FAN25800AUC33X	3.3 V	500 mA	-40°C to 85°C	4-Bump, WLCSP, 0.65 x 0.65 mm, 0.35 mm Pitch	Tape & Reel
FAN25800AUC28X	2.8 V	250 mA			
FAN25800AUCF27X	2.7 V	500 mA			

Note:

1. For other trim options, please contact a Fairchild representative.

Block Diagram

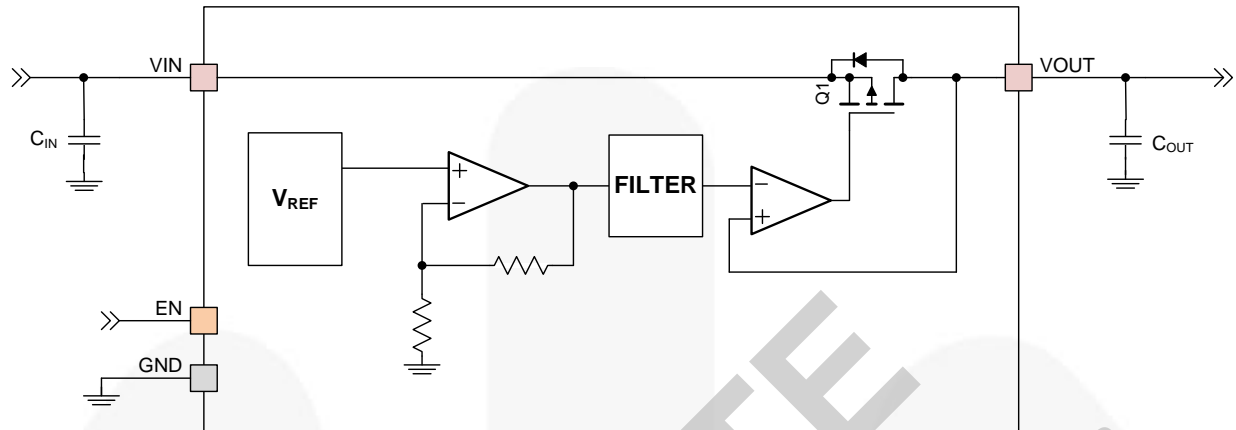

Figure 2. IC and System Block Diagram

Table 1. Recommended External Components

Component	Description	Vendor	Parameter	Typ.	Unit
C _{IN}	1.5 μF, 6.3 V, X5R, 0201	Murata GRM033R60J155M	C	1.5 ⁽²⁾	μF
C _{OUT}	2x1.5 μF, 6.3 V, X5R, 0201	Murata GRM033R60J155M		1.5 ⁽²⁾	μF
C _{Alternative} ⁽³⁾	1.0 μF, 6.3 V, X5R, 0201	Murata GRM033R60J105M		1.0 ⁽²⁾	μF

Notes:

- Capacitance value does not reflect effects of bias, tolerance, and temperature. See *Recommended Operating Conditions and Operation Description* sections for more information.
- C_{Alternative} can be used for both C_{IN} and C_{OUT}. FAN25800 is stable with one 1 μF at C_{IN} and one 1 μF at C_{OUT}.

Pin Configuration

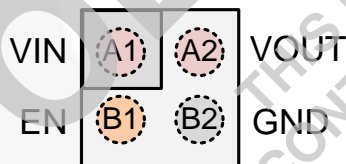

Figure 3. Top-Through View

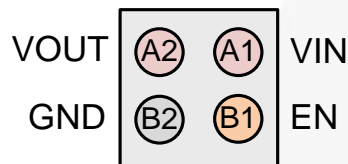

Figure 4. Bottom View

Pin Definitions

Pin #	Name	Description
A1	VIN	Input Voltage. Connect to input power source and C _{IN} .
A2	VOUT	Output Voltage. Connect to C _{OUT} and load.
B1	EN	Enable. The device is in Shutdown Mode when this pin is LOW. No internal pull-down. Do not leave this pin floating. Recommended to not tie EN pin directly to VIN. ⁽⁴⁾
B2	GND	Ground. Power and IC ground. All signals are referenced to this pin.

Note:

- Recommended to use logic voltage of 1.8 V to drive the EN pin.

Absolute Maximum Ratings

Stresses exceeding the absolute maximum ratings may damage the device. The device may not function or be operable above the recommended operating conditions and stressing the parts to these levels is not recommended. In addition, extended exposure to stresses above the recommended operating conditions may affect device reliability. The absolute maximum ratings are stress ratings only.

Symbol	Parameter	Min.	Max.	Unit
V _{IN}	Input Voltage with Respect to GND	-0.3	6.0	V
V _{CC}	Voltage on Any Other Pin (with Respect to GND)	-0.3	V _{IN} +0.3 ⁽⁵⁾	V
T _J	Junction Temperature	-40	+150	°C
T _{STG}	Storage Temperature	-65	+150	°C
T _L	Lead Soldering Temperature, 10 Seconds		+260	°C
ESD	Electrostatic Discharge Protection Level	Human Body Model, ANSI/ESDA/JEDEC JS-001-2012	4000	V
		Charged Device Model per JESD22-C101	1500	
LU	Latch Up	JESD 78D		

Note:

5. Lesser of 6.0 V or V_{IN} + 0.3 V.

Recommended Operating Conditions

The Recommended Operating Conditions table defines the conditions for actual device operation. Recommended operating conditions are specified to ensure optimal performance to the datasheet specifications. Fairchild does not recommend exceeding them or designing to absolute maximum ratings.

Symbol	Parameter	Min.	Typ.	Max.	Unit
V _{IN}	Supply Voltage	2.3		5.5 ⁽⁶⁾	V
I _{OUT_MAX} ⁽⁷⁾	Output Current (V _{OUT} = 2.7 V, 3.3 V)			500	mA
I _{OUT_Recommend}	Output Current (V _{OUT} = 3.3 V)			500	mA
	Output Current (V _{OUT} = 2.7 V, 2.8 V)			250	mA
C _{IN}	Input Capacitor (Effective Capacitance) ⁽⁸⁾	0.4	0.8		μF
C _{OUT}	Output Capacitor (Effective Capacitance) ⁽⁸⁾	0.4	0.8	15.0	μF
T _A	Ambient Temperature	-40		+85	°C
T _J	Junction Temperature	-40		+125	°C

Note:

6. For V_{IN} ≥ 3.4 V, thermal properties of the device must be taken into account at maximum load of 500 mA; refer to θ_{JA} thermal properties.
7. I_{OUT_MAX} is for V_{IN} = V_{OUT} + 0.3 V.
8. Effective capacitance, including the effects of bias, tolerance, and temperature. See the Operation Description section for more information.

Thermal Properties

Junction-to-ambient thermal resistance is a function of application and board layout. This data is measured with four-layer 2s2p boards in accordance to JEDEC standard JESD51. Special attention must be paid not to exceed junction temperature, T_{J(max)}, at a given ambient temperature, T_A.

Symbol	Parameter	Typ.	Unit
θ _{JA}	Junction-to-Ambient Thermal Resistance	180	°C/W

Electrical Specifications

Minimum and maximum values are at $V_{IN} = V_{OUT} + 0.3\text{ V}$; $T_A = -40^{\circ}\text{C}$ to $+85^{\circ}\text{C}$; and test circuit shown in Figure 1. Typical values are at $V_{IN} = V_{OUT} + 0.3\text{ V}$, $T_A = 25^{\circ}\text{C}$, $I_{LOAD} = 10\text{ mA}$, and $V_{EN} = 1.8\text{ V}$, unless otherwise noted.

Symbol	Parameter	Conditions	Min.	Typ.	Max.	Unit
LDO						
I_{IN}	V_{IN} Supply Current	$V_{IN} = V_{OUT} + 0.3\text{ V}$ to 4.2 V , $I_{LOAD} = 0\text{ mA}$		17.0	25.0	μA
		Dropout ⁽¹⁰⁾ , $I_{LOAD} = 0\text{ mA}$		18.5	30.0	
PSRR	Power Supply Rejection Ratio ⁽⁹⁾	$I_{OUT} = 10\text{ mA}$, $V_{IN} = 3.6\text{ V}$, $V_{OUT} = 3.3\text{ V}$	$f = 50\text{ Hz}$		84	dB
			$f = 100\text{ Hz}$		85	
			$f = 1\text{ kHz}$		84	
			$f = 10\text{ kHz}$		79	
		$I_{OUT} = 250\text{ mA}$, $V_{IN} = 3.6\text{ V}$, $V_{OUT} = 3.3\text{ V}$	$f = 50\text{ Hz}$		68	
			$f = 100\text{ Hz}$		73	
			$f = 1\text{ kHz}$		75	
			$f = 10\text{ kHz}$		76	
e_n	Output Noise Voltage Density ⁽⁹⁾	$f = 10\text{ kHz}$, $V_{OUT} = 3.3\text{ V}$	$I_{OUT} = 10\text{ mA}$	20	40	nV/ $\sqrt{\text{Hz}}$
			$I_{OUT} = 250\text{ mA}$	19	39	
e_{n_bw}	Output Noise Voltage (Integrated) ⁽⁹⁾	$f = 10\text{ Hz} - 100\text{ kHz}$, $V_{OUT} = 3.3\text{ V}$	$I_{OUT} = 10\text{ mA}$	8	25	μV_{RMS}
			$I_{OUT} = 250\text{ mA}$	8	25	
V_{DO}	V_{OUT} Dropout Voltage ⁽¹⁰⁾	$V_{OUT} = V_{OUT_TARGET} - 100\text{ mV}$, $I_{OUT} = 250\text{ mA}$		70	130	mV
ΔV_{OUT}	V_{OUT} Voltage Accuracy	$5\text{ mA} \leq I_{OUT} \leq I_{OUT_RECOMMEND}$, $V_{IN} = V_{OUT} + 0.3\text{ V}$ to 4.2 V	-1.9		+1.9	%
ΔV_{OUT_LOAD}	Load Regulation	$I_{OUT} = 5\text{ mA}$ to I_{OUT_MAX}		12	35	$\mu\text{V}/\text{mA}$
I_{LIM}	V_{OUT} Current Limit	$I_{OUT} = 0\text{ mA} \rightarrow$ Current Limit, $V_{OUT} = 3.3\text{ V}$, 2.7 V , V_{OUT} Drops by 2%	550	650	800	mA
		$I_{OUT} = 0\text{ mA} \rightarrow$ Current Limit, $V_{OUT} = 2.8\text{ V}$, V_{OUT} Drops by 2%	275	323	400	
I_{SD}	Shutdown Supply Current	$V_{EN} = 0\text{ V}$, $V_{IN} = V_{OUT} + 0.3\text{ V}$ to 4.2 V		0.125	1.000	μA
V_{UVLO}	Under-Voltage Lockout Threshold	Rising V_{IN}		2.1	2.3	V
V_{UVHYS}	Under-Voltage Lockout Hysteresis			150		mV
t_{START}	Startup Time	Rising EN to 95% V_{OUT} , $I_{OUT} = 10\text{ mA}$		250	500	μs
TSD	Thermal Shutdown	Rising Temperature		150		$^{\circ}\text{C}$
		Hysteresis		20		
Logic Levels: EN						
V_{IH}	Enable High-Level Input Voltage		1.05			V
V_{IL}	Enable Low-Level Input Voltage				0.4	V
I_{EN}	Input Bias Current	$V_{EN} = 1.8\text{ V}$		0.04	1.00	μA

Notes:

- Guaranteed by design; not tested in production.
- Dropout voltage = $V_{IN} - V_{OUTX}$ when V_{OUT} drops more than 100 mV below the nominal regulated V_{OUT} level.

Typical Characteristics

Unless otherwise specified; V_{IN} = 3.6 V, V_{OUT} = 3.3 V, T_A = +25°C, and test circuit per Figure 1.

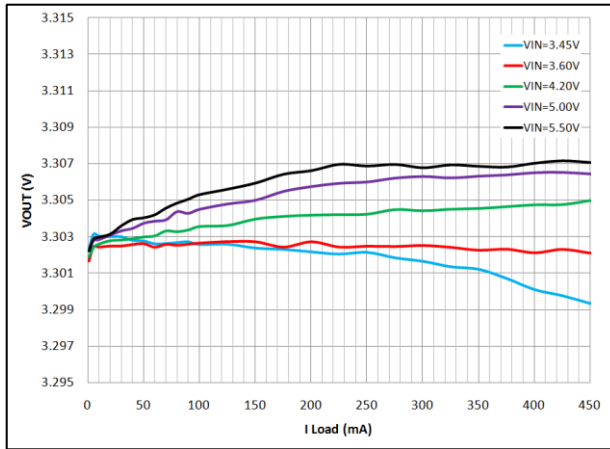

Figure 5. Output Regulation vs. Load Current and Input Voltage

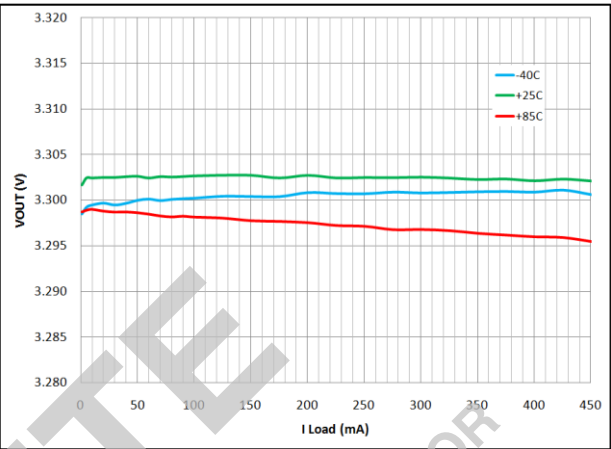

Figure 6. Output Regulation vs. Load Current and Temperature

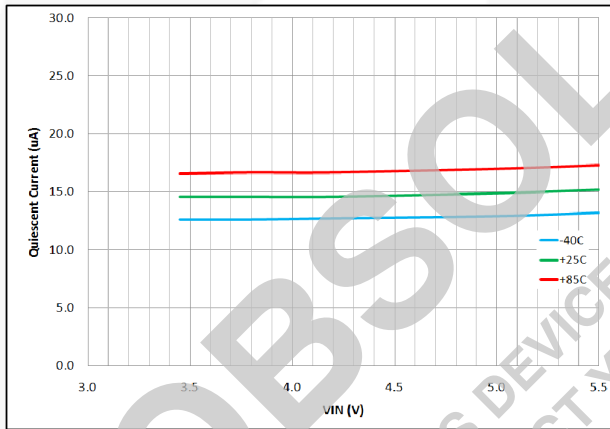

Figure 7. Quiescent Current vs. Input Voltage and Temperature

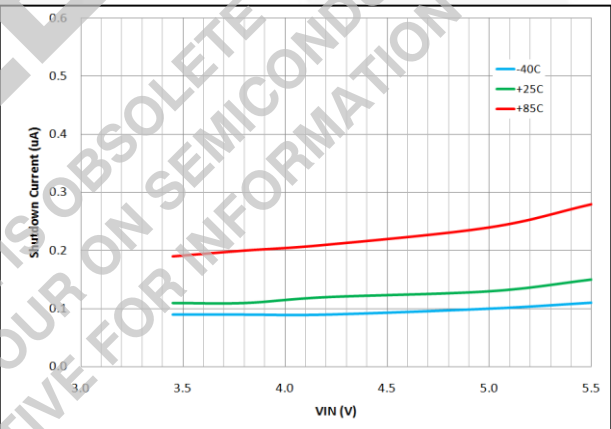

Figure 8. Shutdown Current vs. Input Voltage and Temperature

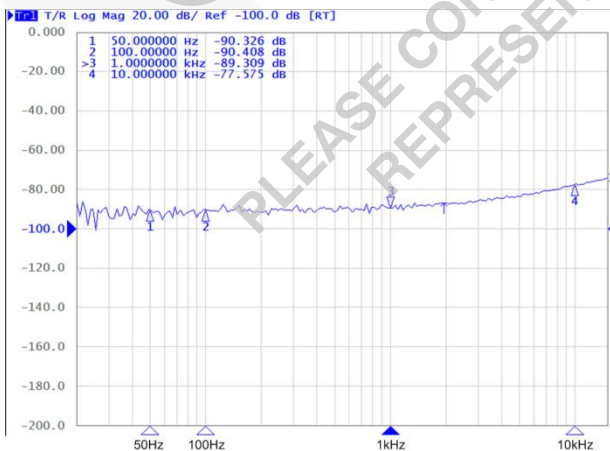

Figure 9. PSRR vs. Frequency, 10 mA Load

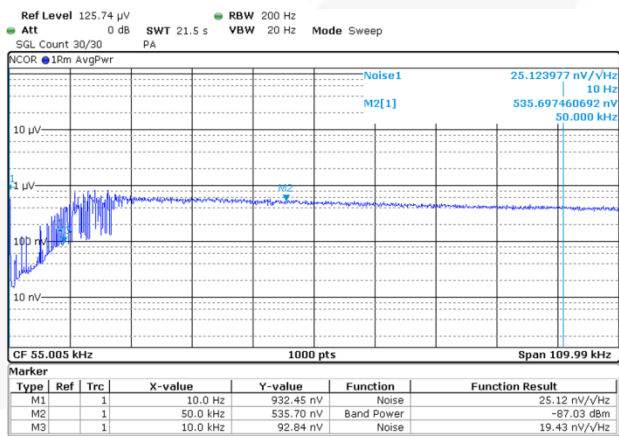

Figure 10. Output Noise Voltage vs. Frequency, 10 mA Load

Typical Characteristics

Unless otherwise specified; $V_{IN} = 3.6\text{ V}$, $V_{OUT} = 3.3\text{ V}$, $T_A = +25^\circ\text{C}$, and test circuit per Figure 1.

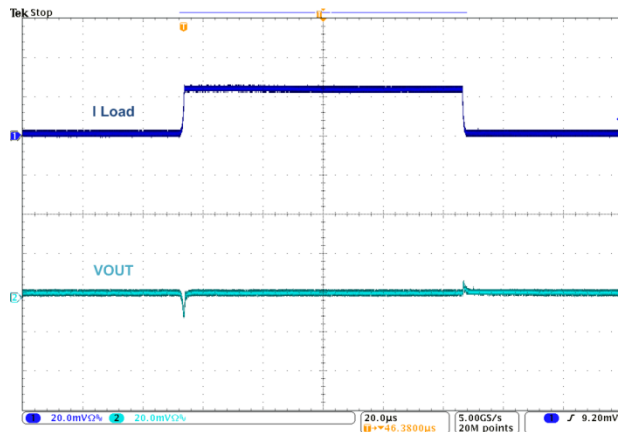

Figure 11. Load Transient, $I_{OUT} = 10 \rightarrow 250 \rightarrow 10\text{ mA}$, $V_{IN}=3.6\text{ V}$, 400 ns Edge

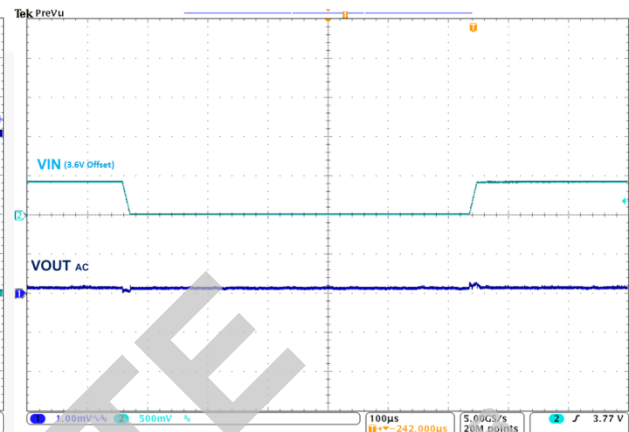

Figure 12. Line Transient, $V_{IN} = 4.0 \rightarrow 3.6 \rightarrow 4.0\text{ V}$, 10 μs Transitions, 10 mA Load



Figure 13. Line Transient, $V_{IN} = 4.0 \rightarrow 3.6 \rightarrow 4.0\text{ V}$, 10 μs Transitions, 250 mA Load

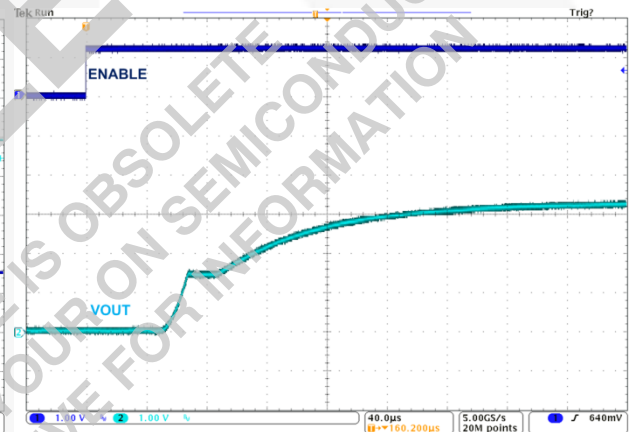

Figure 14. Startup, 10 mA Load

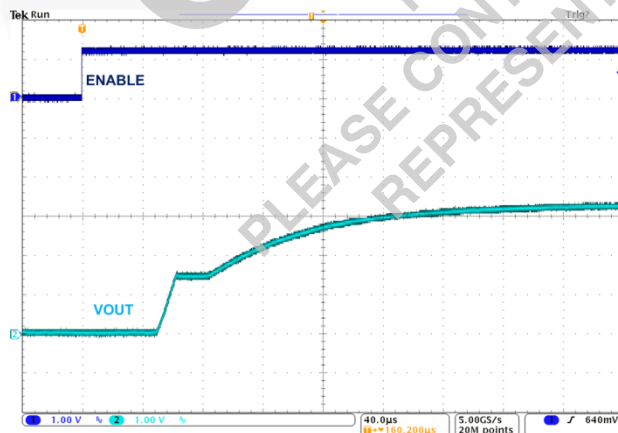

Figure 15. Startup, 250 mA Load

Circuit Description

The FAN25800 is a linear low-dropout (LDO) regulator that has high PSRR and low output noise. The enable control pin can be used to shut down the device and disconnect the output load from the input. During shutdown, the supply current drops below 1 μA. The LDO is designed to be stable with space-saving ceramic capacitors as small as 0201 case size.

Enable and Soft-Start

When EN is LOW, all circuits are off and the IC draws <550 nA of current. The EN pin does not have an internal pull-down resistor and must not be left floating. When EN is HIGH and V_{IN} is above the UVLO threshold, the regulator begins a soft-start cycle for the output. The soft-start cycle controls inrush current, limiting it to the I_{LIM} peak current limit.

Short-Circuit and Thermal Protection

The output current is short-circuit protected. When an output fault occurs, the output current is automatically limited to I_{LIM} and V_{OUT} drops. The resultant V_{OUT} is equal to I_{LIM} multiplied by the fault impedance.

Short-circuit fault or output overload may cause the die temperature to increase and exceed the maximum rating due to power dissipation. In such cases (depending upon the ambient temperature; the V_{IN}, load current, and thermal resistance (θ_{JB}) of the mounted die), the device may enter thermal shutdown.

If the die temperature exceeds the thermal shutdown temperature threshold, the onboard thermal protection disables the output until the temperature drops below its hysteresis value. At that point, the output is re-enabled and a new soft-start sequence occurs.

Thermal Considerations

For best performance, the die temperature and the power dissipated should be kept at moderate values. The maximum power dissipated can be evaluated based on the following relationship:

$$P_{D(max)} = \left\{ \frac{T_{J(max)} - T_A}{\theta_{JA}} \right\} \quad (1)$$

where T_{J(max)} is the maximum allowable junction temperature of the die; T_A is the ambient operating temperature; and θ_{JA} is dependent on the surrounding PCB layout and can be improved by providing a heat sink or surrounding copper ground.

The addition of backside copper with through-holes, stiffeners, and other enhancements can help reduce θ_{JA}. The heat contributed by the dissipation of devices nearby must be included in design considerations.

Capacitor Selection

An output capacitor with an effective capacitance between 400 nF and 15 μF is required for loop stability. The ESR value should be within 3 to 100 mΩ. DC bias

characteristics of the capacitors must be considered when selecting the voltage rating and the case size of the capacitor. Figure 16 is a typical derating curve for a 0201 case size, 1.5 μF, 6.3 V, X5R capacitor.

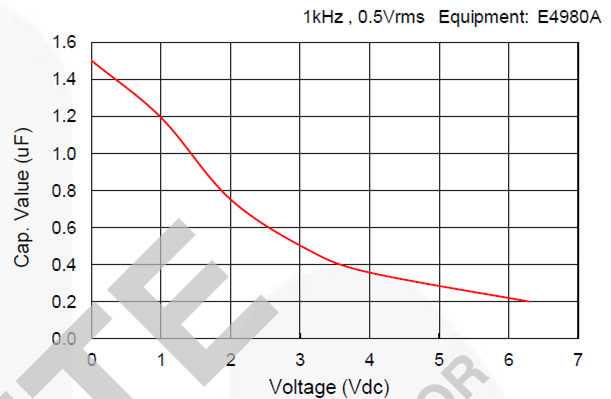

Figure 16. Capacitor DC Bias Characteristics

Typical Application for Post Regulation

Due to its high PSRR and low output noise, the FAN25800 can be used as a post-DC-DC regulator to reduce output ripple and output noise at high efficiency for noise-sensitive applications. Figure 17 shows a post-DC-DC regulation of the LDO with a buck converter. The capacitor on the output of the buck converter can be shared by the LDO as its input capacitor.

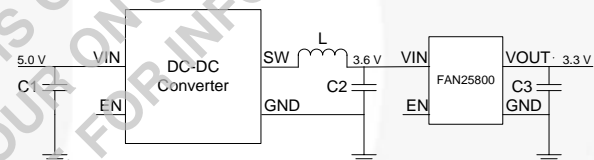

Figure 17. LDO as Post DC-DC Regulator

PCB Layout Recommendations

Capacitors should be placed as close to the IC as possible. All power and ground pins should be routed to their capacitors using top copper. The copper area connecting to the IC should be maximized to improve thermal performance.

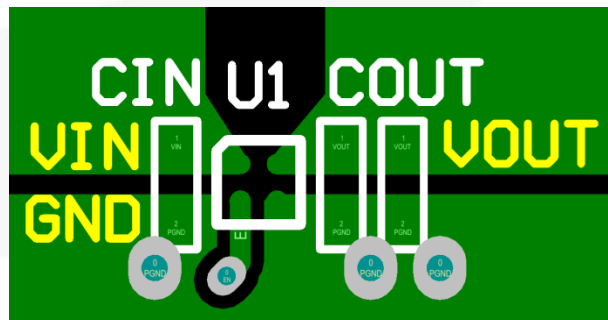

Figure 18. Recommended Layout

Product-Specific Dimensions

D	E	X	Y
0.65 ±0.025 mm	0.65 ±0.025 mm	0.15 mm	0.15 mm

OBSOLETE
 THIS DEVICE IS OBSOLETE
 PLEASE CONTACT YOUR ON SEMICONDUCTOR
 REPRESENTATIVE FOR INFORMATION



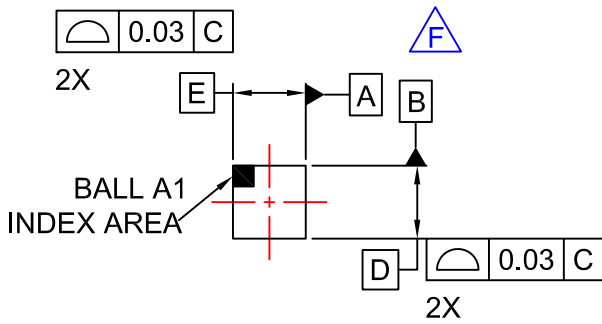

TOP VIEW

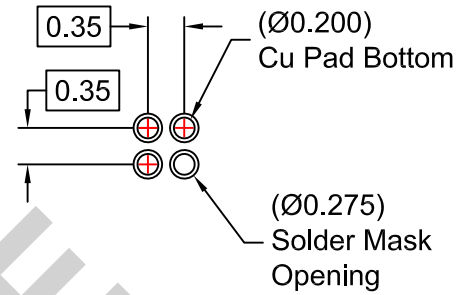

RECOMMENDED LAND PATTERN
(NSMD TYPE)



SIDE VIEWS

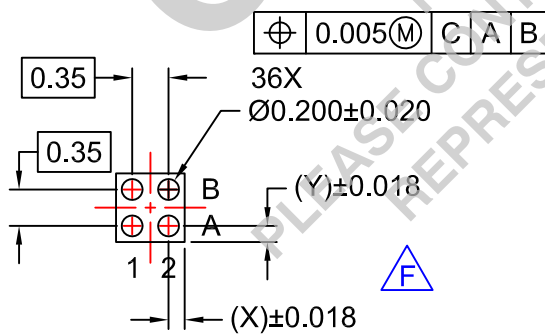

BOTTOM VIEW

NOTES

- A. NO JEDEC REGISTRATION APPLIES.
- B. DIMENSIONS ARE IN MILLIMETERS.
- C. DIMENSIONS AND TOLERANCE PER ASME Y14.5M, 2009.

D. DATUM C IS DEFINED BY THE SPHERICAL CROWNS OF THE BALLS.

E. PACKAGE NOMINAL HEIGHT IS 298 ± 32 MICRONS (266-330 MICRONS).

F. FOR DIMENSIONS D,E,X, AND Y SEE PRODUCT DATASHEET.

G. DRAWING FILNAME: MKT-UC004AK REV1

OBSOLETE
THIS DEVICE IS OBSOLETE
PLEASE CONTACT YOUR ON SEMICONDUCTOR
REPRESENTATIVE FOR INFORMATION

ON Semiconductor and  are trademarks of Semiconductor Components Industries, LLC dba ON Semiconductor or its subsidiaries in the United States and/or other countries. ON Semiconductor owns the rights to a number of patents, trademarks, copyrights, trade secrets, and other intellectual property. A listing of ON Semiconductor's product/patent coverage may be accessed at www.onsemi.com/site/pdf/Patent-Marking.pdf. ON Semiconductor reserves the right to make changes without further notice to any products herein. ON Semiconductor makes no warranty, representation or guarantee regarding the suitability of its products for any particular purpose, nor does ON Semiconductor assume any liability arising out of the application or use of any product or circuit, and specifically disclaims any and all liability, including without limitation special, consequential or incidental damages. Buyer is responsible for its products and applications using ON Semiconductor products, including compliance with all laws, regulations and safety requirements or standards, regardless of any support or applications information provided by ON Semiconductor. "Typical" parameters which may be provided in ON Semiconductor data sheets and/or specifications can and do vary in different applications and actual performance may vary over time. All operating parameters, including "Typicals" must be validated for each customer application by customer's technical experts. ON Semiconductor does not convey any license under its patent rights nor the rights of others. ON Semiconductor products are not designed, intended, or authorized for use as a critical component in life support systems or any FDA Class 3 medical devices or medical devices with a same or similar classification in a foreign jurisdiction or any devices intended for implantation in the human body. Should Buyer purchase or use ON Semiconductor products for any such unintended or unauthorized application, Buyer shall indemnify and hold ON Semiconductor and its officers, employees, subsidiaries, affiliates, and distributors harmless against all claims, costs, damages, and expenses, and reasonable attorney fees arising out of, directly or indirectly, any claim of personal injury or death associated with such unintended or unauthorized use, even if such claim alleges that ON Semiconductor was negligent regarding the design or manufacture of the part. ON Semiconductor is an Equal Opportunity/Affirmative Action Employer. This literature is subject to all applicable copyright laws and is not for resale in any manner.

PUBLICATION ORDERING INFORMATION

LITERATURE FULFILLMENT:

Literature Distribution Center for ON Semiconductor
19521 E. 32nd Pkwy, Aurora, Colorado 80011 USA
Phone: 303-675-2175 or 800-344-3860 Toll Free USA/Canada
Fax: 303-675-2176 or 800-344-3867 Toll Free USA/Canada
Email: orderlit@onsemi.com

N. American Technical Support: 800-282-9855 Toll Free
USA/Canada
Europe, Middle East and Africa Technical Support:
Phone: 421 33 790 2910
Japan Customer Focus Center
Phone: 81-3-5817-1050

ON Semiconductor Website: www.onsemi.com
Order Literature: <http://www.onsemi.com/orderlit>
For additional information, please contact your local
Sales Representative

Mouser Electronics

Authorized Distributor

Click to View Pricing, Inventory, Delivery & Lifecycle Information:

[onsemi:](#)

[FAN25800AUC33X](#) [FAN25800AUC28X](#) [FAN25800AUCF27X](#)